

serres

SERRES NEMO®
Serres Suction bag emptying device

Installation, Operation and Maintenance Instructions

570984

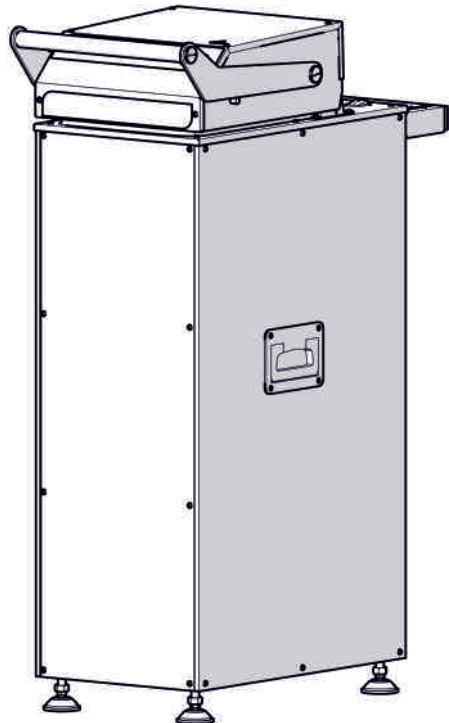

Patent pending, US 2016/0257439 A1
SERRES NEMO® is a registered trademark of Serres OY.

Contents

INTRODUCTION	3
Serres Nemo ® Use Overview	3
Transport and storage	3
Disposal / Recycling	3
WARRANTY	4
Accessories and Replacement Parts	6
SAFETY INSTRUCTIONS AND BIOHAZARD WARNINGS	7
Chemical Safety	8
Electrical Safety	8
INSTALLATION	9
Facility requirements	9
Unpacking the device	9
Regulatory and Building Code Requirements and Permits	10
Installation STEPS	10
USE AND OPERATION OF SERRES NEMO®	11
Opening and closing the lid	11
Placing the suction bag in SERRES NEMO®	12
Emptying the suction bag	12
Operating Switches	14
TROUBLE-SHOOTING	16
Cleaning SERRES NEMO®	18
Cleaning emptying container with the washing tray	19
Maintenance program	19
Usage Counter	20
TECHNICAL SPECIFICATIONS AND DRAWINGS	21

INTRODUCTION

Serres Oy (together with Serres, Inc., its U.S. affiliate, "Serres OY", "we", "us", or the "Manufacturer"), the manufacturer of the Serres Nemo® Suction Bag Emptying Device ("SERRES NEMO®") has prepared these installation, operation and maintenance instructions to ensure that the SERRES NEMO® is installed, used, and maintained correctly and safely.

Read these instructions carefully before installing, using or maintaining SERRES NEMO®. Failure to follow these instructions will void the Manufacturer's Warranty and may result in serious injury to persons or property.

SERRES NEMO® Use Overview

SERRES NEMO® is designed to be used exclusively with Serres standard 2000 and 3000 cc suction bags. SERRES NEMO® is intended for the disposal of medical liquid collected into Serres standard 2000 and 3000 cc suction bags. SERRES NEMO® empties and rinses the content of Serres standard 2000 and 3000 cc suction bags into the sewer system using the water nozzle in the SERRES NEMO which penetrates the suction bag lid, while the water pressure punctures and rinses the suction bag.



WARNING! SERRES NEMO® SUCTION BAG MAY CONTAIN RESIDUAL FLUIDS AFTER EMPTYING AND RINSING CYCLE. SERRES NEMO® DOES NOT DISINFECT THE SUCTION BAG. NOR THE CONTENT OF THE SUCTION BAG. SEE SAFETY INSTRUCTIONS – BIOHAZARD WARNINGS.

Transport and storage

- SERRES NEMO® should be stored indoors in a warm place. The device must be protected from moisture, dirt and dust during transport and storage.
- To ensure the longevity, performance and safety of SERRES NEMO® use of the original packaging material is recommended when storing or transporting.

Disposal / Recycling

- Contamination of and / or injury to environment, persons and property may result from improper disposal when SERRES NEMO® is decommissioned at the end of its useful lifecycle. Prior to disposal contact Serres Inc. Sales/Technical Support for disinfection instructions of SERRES NEMO® review local, state, and federal laws and codes regarding disposal and recycling.

• **DO NOT DISPOSE OF AS UNSORTED MUNICIPAL WASTE.**

■ WARRANTY

Serres OY warrants that the SERRES NEMO® will be free from defects in material and workmanship under normal use for a period of one (1) year from the date of purchase (the "Warranty Period"). The purchaser must examine and inspect SERRES NEMO® for defects, damage or missing parts promptly after the delivery and shall promptly install and test the SERRES NEMO®. A warranty claim must be made to Serres OY within ninety (90) days following the end of the Warranty Period. If we receive a valid warranty claim we will, repair or replace, in our sole discretion, the SERRES NEMO® subject to the exclusions and limitations below. Serres OY's sole responsibility under this warranty is to either repair or replace the SERRES NEMO® with the same or reasonably similar product. When the SERRES NEMO®, or a part or component is replaced, purchaser must provide us (or our authorized repair representative) with the replaced SERRES NEMO®, part or component. The exchanged item becomes purchaser's property and the replaced SERRES NEMO®, part or component becomes our property.

This warranty does not apply and Serres OY will not be responsible for any loss, data loss, damage, or other liabilities arising from: (a) damage from failure to follow instructions relating to SERRES NEMO®'s installation, use, operation, maintenance or disposal; (b) damage cause by improper daily use of SERRES NEMO® washing tray; (c) damage caused by use with non- Serres OY products or from the use of parts, components or accessories that are not manufactured or recommended by Serres OY; (d) damage caused by normal wear and tear, abuse, misuse, intentional or deliberate damage to the product, or force majeure; (e) damage or defect of a non-function part which does not affect SERRES NEMO®'s operation, such as scratches, dents or color differences; (f) damage to SERRES NEMO®, a part or component of SERRES NEMO® that has been repaired or modified by persons other than Serres OY authorized personnel or without the written permission of Serres OY; or (g) if any Serres OY serial number has been altered, removed or defaced.

The remedies provided for in the above warranty are expressly in lieu of any other liability Serres OY may have. Serres OY's cumulative liability to any party for any loss or damage resulting from any claims, demands, or actions arising out of or relating to the SERRES NEMO® will not exceed the purchase price paid by purchaser for the SERRES NEMO® **IN NO EVENT WILL SERRES OY BE LIABLE FOR ANY DIRECT, SPECIAL, INDIRECT, INCIDENTAL, EXEMPLARY, PUNITIVE OR CONSEQUENTIAL DAMAGES, HOWEVER CAUSED, WHETHER FOR BREACH OF WARRANTY, BREACH OF CONTRACT, NEGLIGENCE, STRICT LIABILITY, TORT OR UNDER ANY OTHER LEGAL THEORY, EVEN IF SERRES OY HAS BEEN ADVISED OF THE POSSIBILITY OF THOSE DAMAGES OR IF THOSE DAMAGES COULD HAVE BEEN REASONABLY FORESEEN, AND NOTWITHSTANDING ANY FAILURE OF ESSENTIAL**

PURPOSE OF ANY EXCLUSIVE REMEDY PROVIDED IN THIS WARRANTY. SOME LOCAL LAWS DO NOT ALLOW FOR THE LIMITATION OR EXCLUSION OF LIABILITY FOR INCIDENTAL OR CONSEQUENTIAL DAMAGES, SO THE ABOVE LIMITATION OR EXCLUSION MAY NOT APPLY TO YOU.

TO THE FULLEST EXTENT PERMITTED BY LAW, THIS WARRANTY AND THE REMEDIES SET FORTH ABOVE ARE EXCLUSIVE AND IN LIEU OF ALL OTHER WARRANTIES, REMEDIES, AND CONDITIONS, WHETHER ORAL OR WRITTEN, STATUTORY, EXPRESS OR IMPLIED, AS PERMITTED BY APPLICABLE LAW. SERRES OY SPECIFICALLY DISCLAIMS ANY AND ALL STATUTORY OR IMPLIED WARRANTIES, INCLUDING WITHOUT LIMITATION, WARRANTIES OF MERCHANTABILITY, DESIGN, FITNESS FOR A PARTICULAR PURPOSE, ARISING FROM A COURSE OF DEALING, USAGE OR TRADE PRACTICE, WARRANTIES AGAINST HIDDEN OR LATENT DEFECTS, AND WARRANTIES AGAINST PATENT INFRINGEMENT. IF STATUTORY OR IMPLIED WARRANTIES CANNOT BE LAWFULLY DISCLAIMED, THEN ALL SUCH WARRANTIES ARE LIMITED TO THE DURATION OF THE EXPRESS WARRANTY DESCRIBED ABOVE AND LIMITED BY THE OTHER PROVISIONS CONTAINED IN THIS WARRANTY DOCUMENT.

This warranty is non-transferrable and may only be exercised by the original purchaser of the SERRES NEMO®.

Accessories and Replacement Parts

We maintain replacement parts for several SERRES NEMO® components that may be purchased to replace a component that is damaged or worn. Use of non-Serres OY products, replacements parts or components will void the Warranty, and the manufacturer cannot guarantee the safety of SERRES NEMO®. This list below also contains the detergent that is used daily for cleaning SERRES NEMO®:

DESCRIPTION	REF #
Washing Tray	570985
Inner Seal	57098713
Outer Seal	57098714

Contact information

For technical support or, to make a warranty claim or to order replacement parts or accessories please use contact information below:

Serres Inc.—Sales/ Technical Support
1500 Main Street, Suite 2700
Springfield, MA 01115, USA
Tel. 1-800-634-6594
serres@serres.us

■ SAFETY INSTRUCTIONS AND BIOHAZARD WARNINGS

General

Before installing, using or maintaining SERRES NEMO® it is important that you read and understand the instructions and how SERRES NEMO® operates and how to minimize risks, including the risk of contamination with blood borne pathogens and infectious agents. SERRES NEMO® has been exclusively designed to empty and rinse only Serres 2000 and 3000 cc standard suction bags. Use of non-Serres 2000 or 3000 cc standard suction bags may increase the risk of serious injury to people and property, including death.

Only medical staff and maintenance staff trained in the use and maintenance of SERRES NEMO® and your facility's blood borne pathogens policy should install, use or maintain the SERRES NEMO®.

If SERRES NEMO® has been damaged or parts are missing do not install or use SERRES NEMO®. Contact Sales/Technical Support TEL: 1-800-634-6594.

- **ONLY USE Serres 2000 and 3000 cc Standard Suction Bags with SERRES NEMO®.**
- **DO NOT USE SERRES NEMO® as a trash can or trash disposal device.**
- **DO NOT USE SERRES NEMO® to empty pre-gelled Suction Bags.**



WARNING! BLOODBORNE PATHOGEN HAZARD. INFECTIOUS AGENT HAZARD. USE UNIVERSAL PREAUTIONS. SERRES NEMO® DOES NOT DISINFECT THE SUCTION BAG. SUCTION BAG MAY CONTAIN RESIDUAL FLUIDS AND INFECTIOUS AGENTS AFTER EMPTYING AND RINSING CYCLE. ALWAYS WEAR PERSONAL PROTECTIVE EQUIPMENT.

- **SERRES NEMO® SUCTION BAG MAY CONTAIN RESIDUAL FLUIDS AFTER EMPTYING AND RINSING CYCLE. SERRES NEMO® DOES NOT DISINFECT THE SUCTION BAG.**
- ALWAYS wear personal protective equipment (PPE) when handling SERRES NEMO® or suction bags.
- ALWAYS follow OSHA's Blood borne Pathogens Standard when handling equipment (such as SERRES NEMO®) that comes into contact with medical waste, blood and/or body fluids.
- ESTABLISH a Blood Borne Pathogen Exposure Control Plan. The U.S. Occupational Safety and Health Act of 1970 requires all employers who have an employee(s) with reasonably anticipated occupational exposure to potentially infectious materials to establish a written Exposure Control designed to eliminate or minimize employee exposure through use of personal protective equipment (PPE), appropriate vaccinations (e.g. hepatitis B), and other control measures.

- Purchaser is responsible for obtaining all required local, state, permits for the installation, use and maintenance of SERRES NEMO® and for the collection and disposal of medical waste and body fluids.
- Contamination of environment may result from improper storage or disposal of medical waste and body fluids.



WARNING! CHEMICAL BURN RISK. RISK OF SERIOUS EYE DAMAGE, BLINDNESS, SKIN IRRITATION, INHALATION OR RESPIRATORY INJURY.

Chemical Safety

- SERRES NEMO® washing tray contains neutral detergent with pH 7.5 (14 ml). The detergent contains protease enzyme (<0,1 %) - Sodium capryl iminodipropionate.
- Sodium capryl iminodipropionate may produce an allergic reaction and can cause serious eye damages, skin irritation and/or sensitization by inhalation.
- ALWAYS USE Personal Protective Equipment (PPE) suitable gloves/protective clothing/eye protection/face protection when handling, using or working around Sodium capryl iminodipropionate.
- ALWAYS FOLLOW directions and recommendations provided by detergent manufacturer.
- RINSE EYES IMMEDIATELY if exposed to detergent; REMOVE contact lenses if possible; CONTINUE RINSING and CALL POISON CENTER or health care provider promptly for further instructions.



WARNING! ELECTRICAL SHOCK HAZARD. RISK OF ELECTRICAL SHOCK.

Electrical Safety

- ALWAYS connect SERRES NEMO® to a safety receptacle with a protective earth ground (e.g. 3-prong receptacle). We recommend using a ground fault circuit interrupter (GFCI), however, serious injury or death may still occur (including but not limited to injury from falling following electrical shock).
- ALWAYS disconnect SERRES NEMO® from the main current before maintenance.
- ALWAYS disconnect SERRES NEMO® power plug from the outlet if power cord is damaged; then, contact Serres Sales / Technical support 1-800-634-6594.
- DO NOT USE an extension cable or extension cord with SERRES NEMO®.
- Place SERRES NEMO® close to wall electrical socket so users are able to quickly and easily detach the power plug from wall electrical socket.
- Disconnect the power plug by pulling the plug, not the cable.

■ INSTALLATION

SERRES NEMO® is designed to be installed in a wet room, such as a sluice room. We recommend having a floor drain in a room where SERRES NEMO® is installed.



WARNING! DO NOT INSTALL OR USE SERRES NEMO® WHERE PATIENTS ARE BEING TREATED.

Facility requirements

For proper performance and installation Serres Nemo® requires:

- An open area meeting the specifications described in the Technical Specifications and Drawings.
- A cold water source, water pressure between 14 to 116 psi, supplied by ¾" Male (garden) Hose Thread (MHT) fitting
- A minimum 1,5" sanitary waste line, solid connection with Serres Nemo® and the sanitary waste line. There should be no air gaps in the connection. DO NOT USE an open floor drain
- Electrical power 120 V / 60Hz, facility power receptacle with protective earth (ground). We recommend using a ground fault circuit interrupter (GFCI), however, serious injury or death may still occur (including but not limited to injury from falling following electrical shock).

Tool requirements

- SERRES NEMO® can be installed using standard plumbing tools.

Unpacking the device



**WARNING! HEAVY EQUIPMENT.
USE LIFTING AID OR MULTIPLE PERSONS.
RISK OF MUSCLE STRAIN OR BACK INJURY.**

- SERRES NEMO® has lifting handles on the side covers.
- Only use the lifting handles to lift the SERRES NEMO® from the shipping pallet.
- ALWAYS have more than one person lift this equipment from the shipping pallet.

Regulatory and Building Code Requirements and Permits

Prior to installation, Purchaser should review local, state, and federal laws and code regarding collection and disposal of medical waste, infectious agents and body fluids. Purchaser is responsible for obtaining all required local, state, and federal permits and following applicable laws, regulations and codes for the installation, use and maintenance of SERRES NEMO® and for the collection and disposal of medical waste, infectious agents and body fluids.

Contamination of and / or injury to environment, persons and property may result from improper installation, use, and maintenance of SERRES NEMO® and the storage or disposal of medical waste, infectious agents and body fluids.

Installation STEPS

• STEP ONE: Connect to the water supply network

First attach the water hose adapter on the cold water supply. Then insert the water filter into the connecting hose coupling as shown in the picture. Then connect the appliance to the water hose adapter with its connecting hose (5 ft). $\frac{3}{4}$ " FHT connector is used to connect the SERRES NEMO® inlet hose to the cold water supply.

SERRES NEMO® has an air gap as backflow protection for the water supply network. If the local regulations require other types of backflow protection in addition to air gap, purchaser must install such additional required protections before installing SERRES NEMO®.

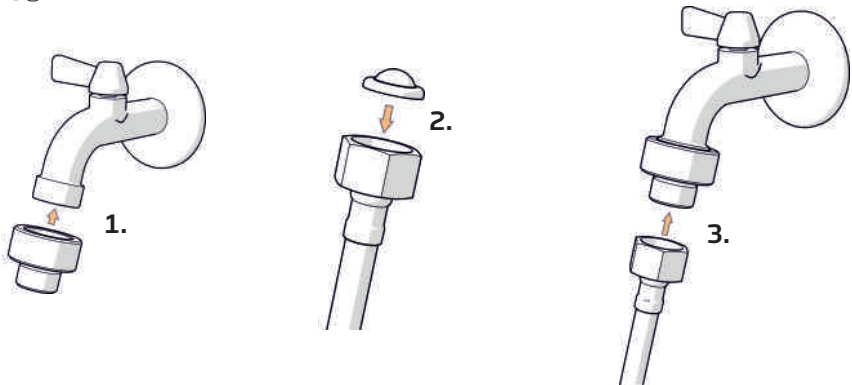

• STEP TWO: Connect to the sanitary waste line

SERRES NEMO® is connected to the sewer network with a 1,5" pipe. The pipe is connected to the bend of SERRES NEMO®'s backside; the bend can be rotated 180°. This connection must be made according to the local regulations, using a pipe with a diameter of at least 1,5" at slope. SERRES NEMO® must not be connected to a sewer via an open sink or open floor drain. There should be no air gaps in the drain connection.

• **STEP THREE: Level SERRES NEMO®**

After making the water and sewer connections, use a level to ensure SERRES NEMO® standing model is level and straight. To do this, place a level at the back of SERRES NEMO® to ensure that it is standing straight. If necessary, adjust its legs. Do not measure straightness from the lid at the top of SERRES NEMO®. Remove protective plastic.

• **STEP FOUR: Fix SERRES NEMO® to wall with the wall bracket**

Use the wall bracket to fix SERRES NEMO® to the wall. Use appropriate wall mount screws required for your wall surface. Mount SERRES NEMO® to the wall with four screws.

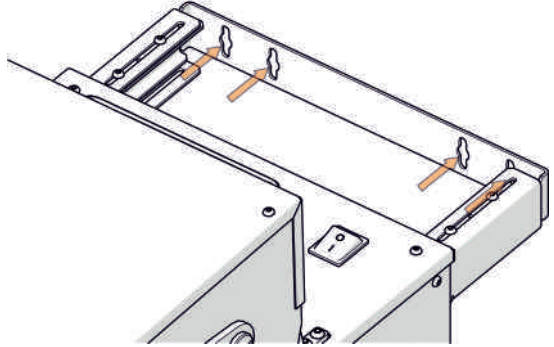

• **STEP FIVE: Connect to the electrical network**

Connect SERRES NEMO® with its power cord (10 ft) to a facility power receptacle with protective earth (ground). We recommend using a ground fault circuit interrupter (GFCI), however, serious injury or death may still occur (including but not limited to injury from falling following electrical shock). DO NOT use power extension cable.

• **STEP SIX: Bleed the internal water pump**

- Turn ON the main switch
- Open the cold-water tap
- Vent the air from the internal water pump by pressing the Play/Pause button on the user interface.
- Run two, first emptying cycles without suction bag.

After installation, test SERRES NEMO®

• **Test SERRES NEMO® operation by emptying five (5) of 3000 CC Serres suction bags**

- Water leakage is not allowed
- The Serres 3000 cc suction bag will break inside SERRES NEMO® in less than 13 seconds – this is normal and a sign that SERRES NEMO® is operating correctly.

■ USE AND OPERATION OF SERRES NEMO®

SERRES NEMO® is designed to be used exclusively with Serres standard 2000 and 3000 cc suction bags. SERRES NEMO® is intended for the disposal of medical liquid collected into Serres standard 2000 and 3000 cc suction bags.



WARNING! DO NOT USE SERRES NEMO® TO EMPTY PRE-GELLED STANDARD SUCTION BAGS! USER TRAINING REQUIRED BEFORE USE TO REDUCE RISK OF INJURY TO PERSONS OR PROPERTY, INCLUDING DEATH.

Opening and closing the lid



WARNING! RISK OF CRUSH INJURY. WATCH OUT FOR YOUR FINGERS WHEN OPENING AND CLOSING LID.

SERRES NEMO® lid is opened and closed by lifting or lowering the handle on the lid. For safety reasons, the device lid cannot be opened while the program is running.

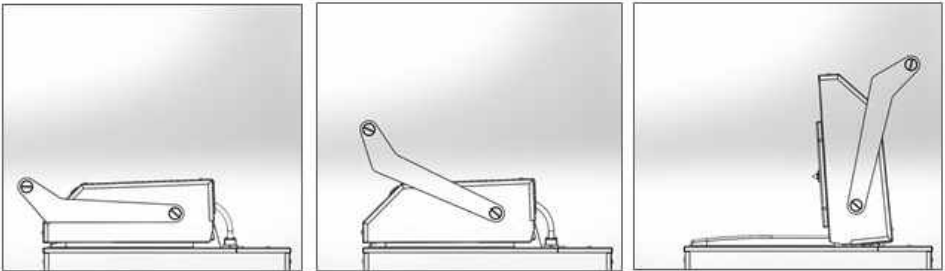

Placing the suction bag in SERRES NEMO®

· The suction bag to be emptied is placed in SERRES NEMO® with the bag's lid on top of the set collar. The suction bag can be installed in any position.

· The spill basin around the emptying container collects any liquid that may have leaked outside the suction bag in case of a fault.

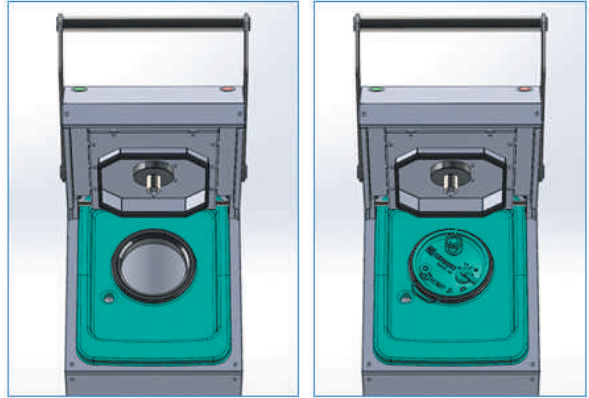

· **The suction bag's angled connector and a possible serial connector must be removed. The connections in the suction bag must be plugged before using the emptying device!**

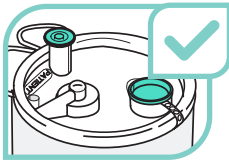

Correctly plugged suction bag

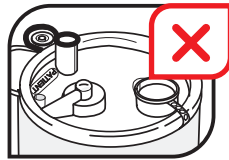

Unplugged patient connector

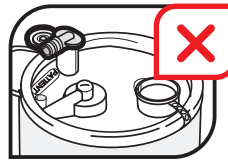

Angled connector still in place

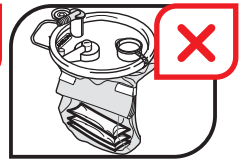

Pre-gelled suction bag

Emptying the suction bag

· Make sure that the angled and serial connectors in the suction bag to be emptied have been removed and that the connectors have been plugged.

· Open SERRES NEMO® lid (see above).

· Place the suction bag to be emptied into the emptying device (see above).

· Close SERRES NEMO® lid by pressing the handle on the lid, until the lid locks (see above). A GREEN light blinks for five seconds.

· Start the emptying program by pressing the play/pause button on the front panel of the lid. A YELLOW light will be on.

· SERRES NEMO® will run an emptying program that lasts for approximately 20 seconds. After this, SERRES NEMO® will shut down automatically. A GREEN light will be on.

· When the emptying program is finished, and the GREEN light is on, the lid can be opened and the empty suction bag can be removed from SERRES NEMO®.

· The emptied, rinsed suction bag must be disposed of in accordance with your facilities specific instructions for disposing of medical waste and waste containing infectious agents and body fluids.



WARNING! BLOODBORNE PATHOGEN HAZARD. INFECTIOUS AGENT HAZARD. USE UNIVERSAL – BLOOD BORNE PATHOGEN PRECAUTIONS. SERRES NEMO® DOES NOT DISINFECT THE SUCTION BAG. SUCTION BAG MAY CONTAIN RESIDUAL FLUIDS AND INFECTIOUS AGENTS AFTER EMPTYING AND RINSING CYCLE. ALWAYS WEAR PERSONAL PROTECTIVE EQUIPMENT.

Operating Switches

SERRES NEMO® has a main on/off switch on the back of the lid. It is not necessary to turn off SERRES NEMO® during normal usage. The  indicator LED shows when the power is on.

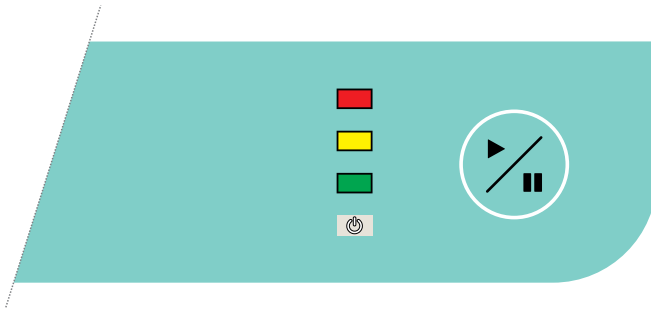

· The front panel of SERRES NEMO® has a play/pause button and four (4) LED lights. SERRES NEMO® is started by pressing the play/pause button and paused by pressing the same button.

· **The bottom LED light is ON** means the power is on.

· **GREEN light is BLINKING**

When the suction bag has been installed on the collar set and the lid is closed (safety lock is on) the GREEN light blinks for 5 seconds, showing the lid is properly closed.

· **GREEN light is ON** means the 20 second cycle is finished

· **YELLOW light is ON** for 20 seconds means the program cycle is running

• YELLOW light is BLINKING

SERRES NEMO® water tank is not full, when SERRES NEMO® fills the water tank the cycle will start automatically; filling the water tank can take few seconds. SERRES NEMO® water tank must be full in order for SERRES NEMO® to start. If several suction bags are emptied, one after another, the water tank may not have had time to fill between bags. Yellow blinking light will stop when water tank is full. If blinking continues for more than 30 seconds, check that the water supply tap is open. If the problem continues, contact Technical Support.

• RED light is ON

This indicates the following has occurred –

- The play/pause button was pressed during program cycle
- SERRES NEMO® handle was lifted during program cycle
- Power failure occurred during program cycle



PRESS the play/pause button again to restart the cycle

TRUBLE-SHOOTING

PROBLEM: Power indicator light is not ON	
<p>CAUSE: Power cord is not connected or is loosely connected</p>	<p>SOLUTION: Make sure power cord is connected securely.</p>
<p>CAUSE: Power switch is in OFF position at the back of the equipment</p>	<p>SOLUTION: Make sure the power switch is in ON position</p>

PROBLEM: Emptying cycle did not start. YELLOW light is BLINKING	
<p>CAUSE: Water supply breakdown</p>	<p>SOLUTION: Check that cold water connection is functional, and facility water tap is open.</p>

PROBLEM: Emptying cycle did not start.	
<p>CAUSE: Lid is not closed properly</p>	<p>SOLUTION: Place the lid handle in down position. Then press down firmly with two hands until green LED starts blinking (for five seconds) and electronic lock has clicked. Press the play button to start the cycle</p>

PROBLEM: Liquid leakage	
<p>SOLUTION: If there is liquid leaking, stop the program cycle by pressing the Play/Pause button and disconnect power cord. Contact Serres Inc. Sales/Technical support If there is liquid leaking, stop the program cycle by pressing the Play/Pause button and disconnect power cord. Contact Serres Inc. Sales/Technical support 1-800-634-6594</p>	

PROBLEM: Lid cannot be opened. RED light is ON.	
CAUSE: There has been power interruption during the emptying cycle	SOLUTION: Press the Play/pause button and wait until emptying cycle is finished and green light is on
CAUSE: SERRES NEMO® lid handle has been lifted up before the emptying cycle has ended and green light is on	SOLUTION: Press the Play/pause button and wait until emptying cycle is finished and green light is on
CAUSE: User has pressed the Play/Pause button during the emptying cycle	SOLUTION: Press the Play/pause button and wait until emptying cycle is finished and green light is lit

PROBLEM: Suction bag rinsing result is poor
SOLUTION: Restart program cycle by pressing the play/pause button. If the fault persists, contact the Serres Inc. Sales/Technical support 1-800-634-6594

PROBLEM: Suction bag does not empty
SOLUTION: Restart program cycle by pressing the play/pause button. If the fault persists, contact the Serres Inc. Sales/Technical support 1-800-634-6594

Other problems:
Contact Serres Inc. Sales/Technical support 1-800-634-6594

Cleaning SERRES NEMO®

- CLEAN exterior of SERRES NEMO® by wiping it with a cleaning agent intended for disinfecting hospital equipment.
- CLEAN DAILY. The emptying chamber must be cleaned daily by running program cycle with a washing tray. The washing tray is disposable. If SERRES NEMO® is not clean following running program cycle, call Serres inc. Sales/Technical Support.
- DO NOT use abrasive detergents or solvents to clean the device.
- DO NOT immerse any system component in liquid.
- DO NOT rinse SERRES NEMO® with a hose.
- DO NOT allow liquids or moisture to enter any electrical connection.
- DO NOT sterilize any system component.



WARNING! CHEMICAL BURN RISK. RISK OF SERIOUS EYE DAMAGE, BLINDNESS, SKIN IRRITATION, INHALATION OR RESPIRATORY INJURY. USE PPE WHEN HANDLING WASHING TRAY DETERGENT

- SERRES NEMO® washing tray contains neutral detergent with pH 7.5 (14 ml). The detergent contains protease enzyme (<0,1 %) - Sodium capryl iminodipropionate.
- Sodium capryl iminodipropionate may produce an allergic reaction and can cause serious eye damages, skin irritation and/or sensitization by inhalation.
- ALWAYS USE Personal Protective Equipment (PPE) suitable gloves/protective clothing/eye protection/face protection when handling, using or working around Sodium capryl iminodipropionate.
- ALWAYS FOLLOW directions and recommendations provided by detergent manufacturer.
- RINSE EYES IMMEDIATELY if exposed to detergent; REMOVE contact lenses if possible; CONTINUE RINSING and CALL POISON CENTER or health care provider promptly for further instructions.

Cleaning emptying container with the washing tray

The daily use of disposable washing trays ensures that emptying container is hygienic and is required for SERRES NEMO® to function as intended. Place washing tray into SERRES NEMO® with enough detergent for cleaning the emptying container. PLEASE NOTICE - SERRES NEMO® washing tray does not disinfect the emptying container of SERRES NEMO®. The washing tray also seals the emptying container, preventing water and contaminants from splashing outside SERRES NEMO® during the program cycle. Follow these steps to clean emptying container:

- **STEP ONE:** Open lid (see instructions Opening and Closing Lid)
- **STEP TWO:** Place the disposable washing tray on the set collar of the emptying device.
- **STEP THREE:** Close lid by pressing the handle on the lid until the lid locks, and start the program by pressing the play/pause button on the front panel of the lid. SERRES NEMO® will run a 20 second program cycle and then shut down automatically.
- **STEP FOUR:** When the program cycle has ended, the lid can be opened and the used washing tray can be removed.



WARNING! SUCTION BAG MAY CONTAIN RESIDUAL FLUIDS AFTER EMPTYING AND RINSING CYCLE. SERRES NEMO® DOES NOT DISINFECT THE SUCTION BAG. BLOODBORNE PATHOGEN HAZARD. INFECTIOUS AGENT HAZARD. USE UNIVERSAL – BLOOD BORNE PATHOGEN PRECAUTIONS. ALWAYS WEAR PERSONAL PROTECTIVE EQUIPMENT.

Maintenance program



WARNING! ELECTRICAL SHOCK HAZARD. RISK OF ELECTRICAL SHOCK. Only individuals trained and experienced in the maintenance of electrical devices should install, inspect, and test SERRES NEMO®.

Follow the maintenance and inspection schedule below for SERRES NEMO® to operate as intended. DO NOT use any equipment if damaged or the inspection criteria not met.

- **EVERY SIX (6) MONTHS:** CHANGE inner seal of the lid (Order #57098713). If inner seal shows signs of wear and tear before six months change inner seal sooner.
- **EVERY TWENTY-FOUR (24) MONTHS:** CHANGE Outer seal of the lid (Order #57098714). If outer seal shows signs of wear and tear before twenty-four months change outer seal sooner.

- **EVERY TWENTY-FOUR (24) MONTHS:** CONDUCT periodic maintenance as follows:
 - INSPECT SERRES NEMO® components for wear and replace when worn.
 - INSPECT plumbing connections and hoses for leaks.
 - INSPECT water filter for inlet water hose
 - INSPECT power cord for cuts.
 - INSPECT power core receptacle for bent pins.
 - RUN performance test. SERRES NEMO® should meet manufacturer's specifications.

For periodic maintenance and service, call Serres Ins. Sales / Technical support 1-800-634-6594.

Usage Counter

SERRES NEMO® has a counter which indicates usage count. PRESS the play/pause button for ten (10) seconds when the lid is completely opened to see counter statistics – indicator lights will start to blink. The blink sequence can be reactivated by pressing the play/pause button again. PRESS the play/pause button again for ten (10) seconds or just close the lid to return the device to a normal operating state.

All blinks are counted:

- RED light indicates tens of thousands of cycles
- YELLOW light indicates thousands of cycles
- GREEN light indicates hundreds of cycles

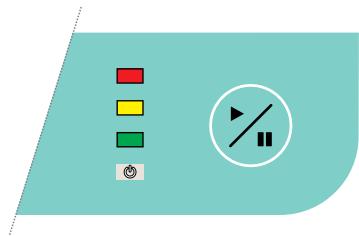

For example: If there have been less than 100 rinse cycles, there will be no blinks. With 199 rinse cycles, there will be one blink of a green light. 11299 rinse cycles is indicated by one red, one yellow and two green blinks.

TECHNICAL SPECIFICATIONS AND DRAWINGS

MODEL: SERRES NEMO® - Serres suction bag emptying device
REFERENCE NUMBER: 570984

TECHNICAL SPESIFICATIONS:

Installation: SERRES NEMO® is floor standing, see "Installation" page 7
Electrical connection: 120V / 60 Hz (power cord 10 ft) Power plug, NEMA 5-15P
Cold water connection: FHT ¾" (connecting hose 5 ft)
Sewer system: 1,5" male push-fit (bend)
Water supply pressure: 14 - 116 psi (1 - 8 bar)
Water supply temperature: +41°F to +76°F
Cycle duration: 20 seconds
Temperature Limitation: Operation +59°F to +95°F Transportation and Storage -4°F to +131°F
Humidity: 5 % to 95 %
Altitude: up to 2000 m
Current consumption: 8.8 A
Decibel level: dB Max 78 / Min 45 / Avarage 61. dB(A) Max 71 / Min 7 / Avarage 46
Water volume in one cycle: 2.1 gallons:
Back-siphonage protection: SERRES NEMO® has an air gap as back-siphonage protection for the water supply network.
MATERIAL: Stainless steel, Plastic
WEIGHT: 133 lb + 29 lb packing material
DIMENSIONS: Width: 13" Depth: Max 30.3" Height: Max 41.7"
Height, lid open: Max 51.2"
GROUND TYPE: Protective earth

PRODUCT SAFETY CERTIFICATION:



Electrical Equipment For Laboratory Use
· UL 61010-1
· CAN/CSA C22.2 No. 61010-1-12

STANDARDS:

Following harmonized standards have been applied:

- IEC 61010-1:2017
- ASME A112.1.2-2012
- ISO 7000:2014
- EN ISO 12100:2010
- CFR 47 Subpart 15, Part B / ISES 003

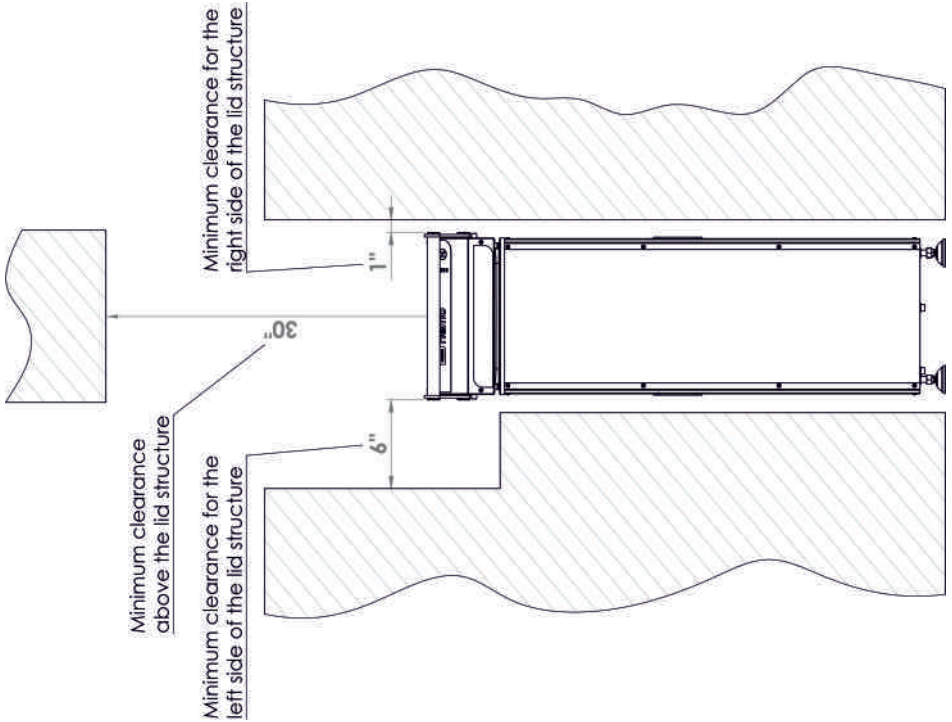
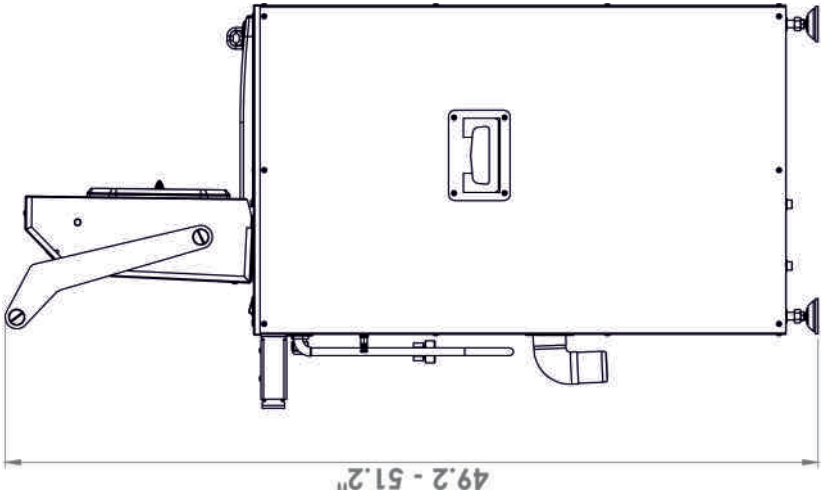

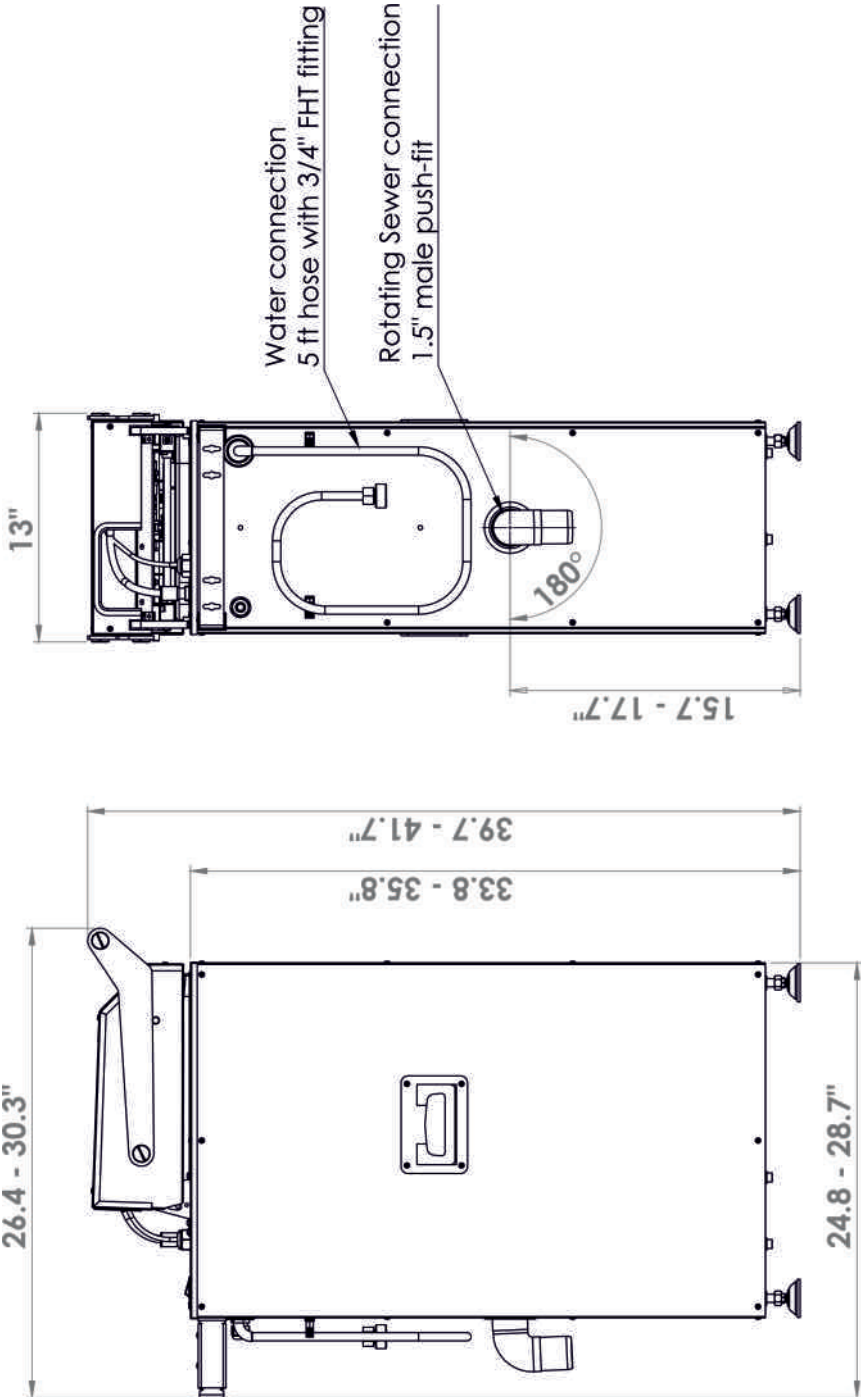

Manufacturer:

serres

Serres Oy
Keskustie 23
61850 Kauhajoki as, Finland
tel. +358 20 746 4400
faks +358 20 746 4401
serres@serres.com

www.serres.us

6001003 06/2018